



Half Round & Riteline 150 Hi-Front Gutters



This stylish, high capacity gutter is available in both Half Round and Riteline 150 Hi-Front (flat back) styles.

The unique curved base of the gutter prevents build-up of water and dirt, allowing the gutter to clean itself with every shower of rain.

Match or contrast existing surfaces with 23 COLORBOND® steel colours available (plus unpainted ZINCALUME® steel).

Half Round & Riteline 150 Hi-Front Gutters

SIMPLE INSTALLATION

With a complete range of easy fix accessories and brackets the installation of both the Half Round and Riteline 150 Hi-Front gutter system has never been easier.

HALF ROUND

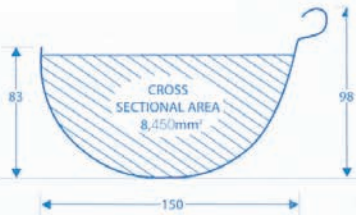

EASY FIX ACCESSORIES



EXTERNAL POWDERCOATED BRACKET



EXTERNAL CORNER

INTERNAL CORNER

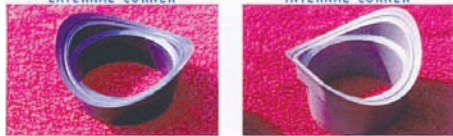

90MM DROP

100MM DROP

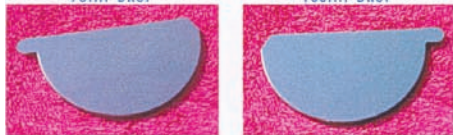

RIGHT HAND STOP END

LEFT HAND STOP END

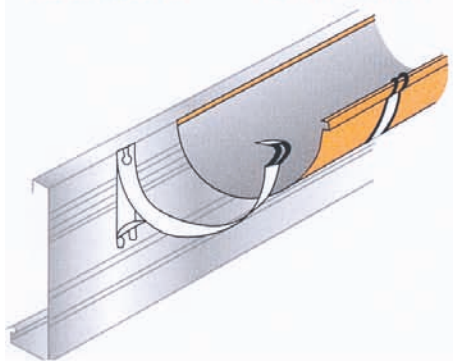

RITELINE 150 HI-FRONT

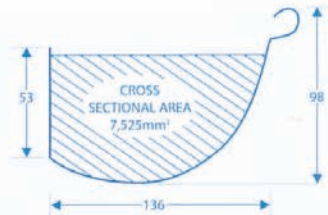

EASY FIX ACCESSORIES

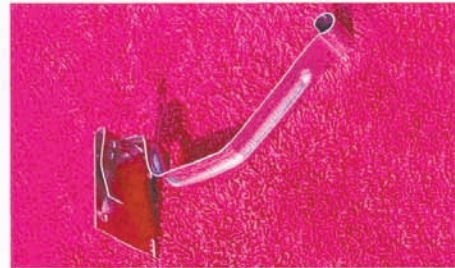

INTERNAL CONCEALED BRACKET

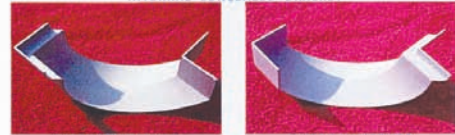

EXTERNAL CORNER

INTERNAL CORNER



90MM DROP

100MM DROP



LEFT HAND STOP END

RIGHT HAND STOP END

